

TOOLS REQUIRED

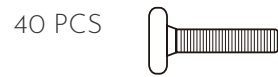
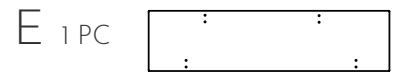
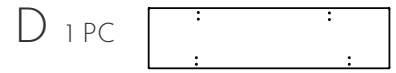
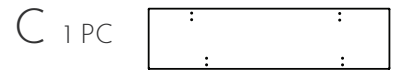
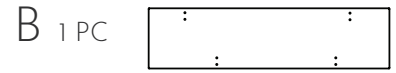
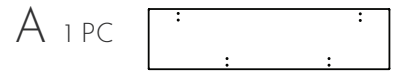
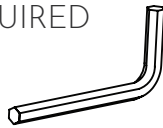

## STEP 01

PLACE SHELF A ON THE SUPPORT BRACKETS ON ALL FOUR LEGS. SECURE TO THE LEGS WITH TWO SCREWS PER BRACKET. REPEAT FOR EACH BRACKET.

PLACE SHELF E ON THE SUPPORT BRACKETS ON ALL FOUR LEGS. SECURE TO THE LEGS WITH TWO SCREWS PER BRACKET. REPEAT FOR EACH BRACKET.

**NOTE:** EACH LEG IS DIFFERENT WITH A NUMBER MARKED AT THE BOTTOM. THE SCREW HOLE ON THE LEG AND BOARD SHALL BE MATCHED CORRECTLY WITH SAME LABEL CODE BEFORE FASTENING.

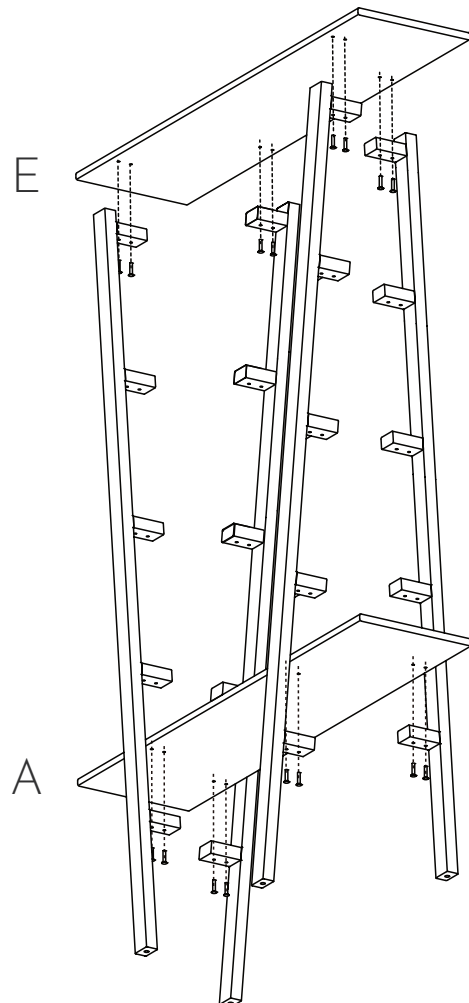

# STEP 02

PLACE SHELF C ON THE SUPPORT BRACKETS ON ALL FOUR LEGS. SECURE TO THE LEGS WITH TWO SCREWS PER BRACKET. REPEAT FOR EACH BRACKET.

PLACE SHELF B ON THE SUPPORT BRACKETS ON ALL FOUR LEGS. SECURE TO THE LEGS WITH TWO SCREWS PER BRACKET. REPEAT FOR EACH BRACKET.

PLACE SHELF D ON THE SUPPORT BRACKETS ON ALL FOUR LEGS. SECURE TO THE LEGS WITH TWO SCREWS PER BRACKET. REPEAT FOR EACH BRACKET.

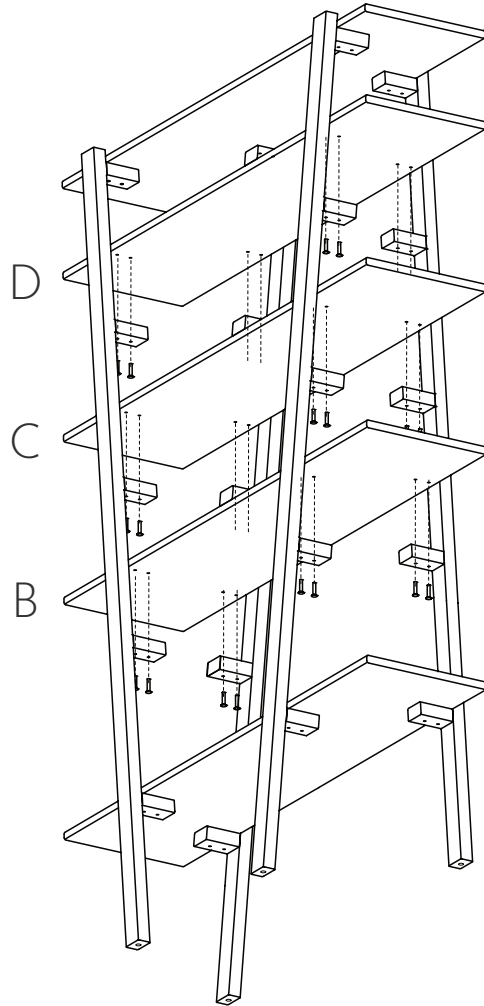



# BRUTUS SAFETY BRACKET

SAFETY BRACKET IS REQUIRED TO BE USED FOR ASSEMBLING THE BOOKSHELF.

LOCATE IN YOUR SPACE WHERE YOU WANT YOUR BOOKSHELF TO BE LOCATED. IF POSSIBLE, LOCATE A STUD TO SECURE THE SAFETY BRACKET. DRILL TWO HOLES INTO THE WALLBOARD AND FILL WITH THE PLASTIC EXPANSION SCREWS (D). ATTACH THE BRACKET (C) TO THE WALLBOARD WITH TWO LONG SCREWS (B).

SECURE THE OTHER SECURITY BRACKET (C) TO ONE OF THE BOOKSHELF LEGS/FRAME WITH TWO SHORT SCREWS (A).

MOVE THE BOOKSHELF INTO ITS FINAL POSITION. THREAD A STRAP (E) THROUGH THE SECURITY BRACKETS AS SHOWN IN THE ILLUSTRATION, TIGHTEN STRAP UNTIL SNUG. DO NOT OVERTIGHTEN.

MAKE SURE THE SECURITY BRACKETS ARE FIRMLY ASSEMBLED TO THE WALL AND BOOKSHELF FRAME.

